

INSTALLATION ADJUSTMENT SERVICE PROTON VALVE

IMPORTANT! Provide serial number when ordering parts!!



WARNING: This product can expose you to chemicals including lead, which is known to the State of California to cause cancer. For more information, go to www.P65Warnings.Ca.gov



INSTALLATION AND FIELD ADJUSTMENTS ARE THE RESPONSIBILITY OF INSTALLER. READ ALL INSTRUCTIONS PRIOR TO INSTALLATION



1. Leonard Proton Valves are factory pre-assembled and tested and include digital mixing valve and controls which function as a system to meet both high and low demand for tempered water.
2. System should be installed at a location where it can easily be cleaned, adjusted or repaired.
3. System supplies must be connected as shown (Hot-left, Cold-right). Exercise caution when soldering.

4. Flush pipes thoroughly after system has been connected.
5. This assembly **MUST** be piped according to **LEONARD'S REQUIRED PIPING METHOD W.**
6. Refer to pages 2-3 of this bulletin for correct Setup Instructions.
7. **Suitable for indoor use only**

Model PNV-100-LF – 3/4” Inlets, 1” Outlet

Model PNV-125-LF – 1” Inlets and 1.25”Outlet

Model PNV-150-LF – 1.25” Inlets, 1.5” Outlet

Model PNV-150-LF-LCV – 1.25” Inlets, 1.5” Outlet (less check valves)

Check valves are recommended to prevent cross-flow on “LCV” models

Model PNV-200-LF – 2” Inlets and 2”Outlet

Model PNV-200-LF-LCV – 2” Inlets and 2”Outlet (less check valves)

Model PNV-300-LF – 3” Inlets and 3”Outlet

Model PNV-300-LF-LCV – 3” Inlets and 3”Outlet (less check valves)

Check valves are recommended to prevent cross-flow on “LCV” models

Maximum Operating Pressure 200PSI (13.8 BAR), valve only

Hot Water Temperature Range: 120° - 180°F (49° - 82°C)

Cold Water Temperature Range: 39° - 80°F (4° - 27°C)

Temperature Adjustment Range: 65° - 180°F (18° - 82°C)

1360 Elmwood Avenue, Cranston, RI 02910 USA

Phone: 401.461.1200 Fax: 401.941.5310

Email: info@leonardvalve.com

Web Site: <http://www.leonardvalve.com>

PROTON 1.0 – SETUP INSTRUCTIONS

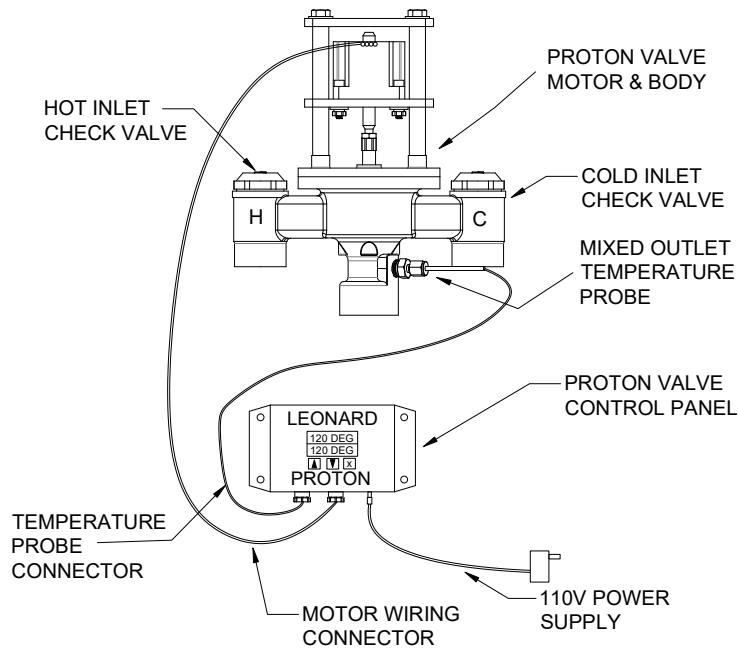

The Proton Control Box has a 2 Line, 16 character LED digital display screen, which serves as the User Interface by utilizing a simple 3-button keypad interface: ▲, ▼ and ENTER, to change temperature see page 5.

On Initial Power up, the valve will go through a full sweep function, which moves the motor its full travel, end-to-end of hot and cold ports of the valve body. This process assigns a numerical value to the distance travelled by the motor, in steps, that will be used in future comparisons to indicate if there is a potential maintenance problem or internal mechanical issue with the components of the valve.



WARNING



The Leonard Proton Digital Mixing Valve is an electronically controlled device utilizing DC circuitry. The connection of the Electronic Control Box to the Mechanical Valve Components is very simple. There is a 3-wire RTD Temperature Probe as well as a 4-wire Motor Harness that must be connected and plugged into the box on the left and middle (respectively) connection points on the bottom of the Control Box. The 110V Power to the box is accomplished through the barrel connector on the bottom right side of the Control Box. Installer must follow detailed instructions below to ensure proper operation of valve.

Valve assembly is suitable for indoor use only

Valve outlet must face down and be piped to Method W, see page 25



•NOTE! READ ALL INSTRUCTIONS PRIOR TO INSTALLATION



PROTON 1.0 – INSTALLATION INSTRUCTIONS

1. The Proton Unit MUST be piped according to Leonard Required Piping Method W (see page 25).
2. Mount valve body, outlet facing down, and plumb inlet and outlet connections. DO NOT introduce water to the valve until completion of these instructions.
3. Mount Proton Control Box to desired location, within 6' of Valve Body using suitable screws at 4-hole locations on Control Box. Ensure all wiring connected to the Control Box is accessible.
4. Remove compression fitting from rear-right side of the valve outlet. Slide RTD Probe #1 through the compression fitting and insert into the rear-right side of the valve outlet. Tighten compression fitting by hand, and then tighten just 1/8 to 1/4 turn. DO NOT overtighten fitting. See page 24 for more detail.
5. Connect and plug in, see pictures below, the 3-wire RTD Temperature Probe connector into the bottom left connection point on the Control Box. Single-pin facing left side, press tab facing the back, and press connector all the way in until firmly engaged and an audible “click” is heard.
6. Connect and plug in, see pictures below, press tab facing the back, the 4-wire Motor Connector into the bottom center connection point on the Control Box. Press the connector all the way in until firmly engaged and an audible “click” is heard.
7. Connect Barrel Connector to bottom right side of Control Box. This is 110Volt Power Supply.
8. Open all inlet and outlet check-stops and ball valves to pressurize Proton valve.
9. Plug power supply into 110V receptacle. GFCI receptacles are recommended. Installer to follow local electrical codes.
10. Powering Valve Control Box will cause the valve motor to initiate a FULL VALVE SWEEP (End to End), indicating that the motor has traveled 900-1500 Steps. Please Record this initial Full Valve Sweep Value _____ Following the FULL SWEEP, the valve is ready for use and the LED Screen will display the following:

ALIGNED CORRECTLY



ALIGNED CORRECTLY

ALIGNED WRONG

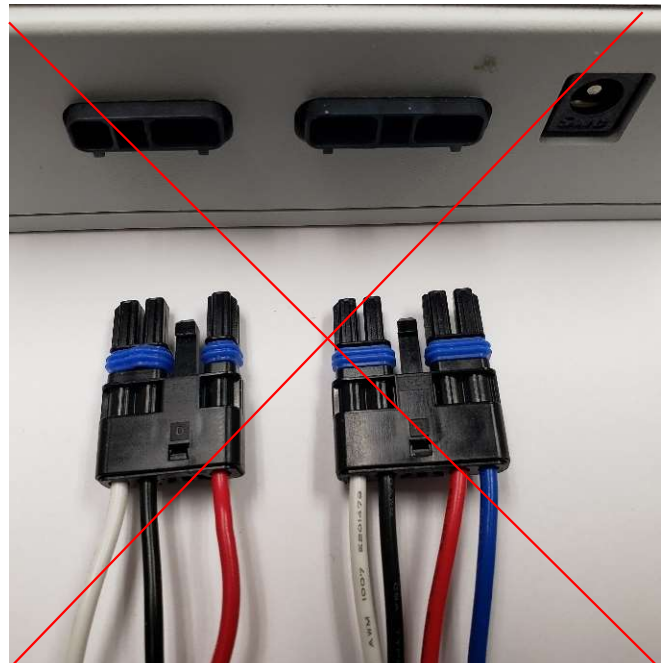

ALIGNED WRONG

PROTON 1.0 - DEGREES "F" OR "C"

Protons can display in either degrees "F" Fahrenheit or degrees "C" Celsius. The units come standard as degrees "F" Fahrenheit. To change the units to degrees "C" Celsius it is as simple as removing a "jumper" on the board on the back on the control box as seen in the pictures below.

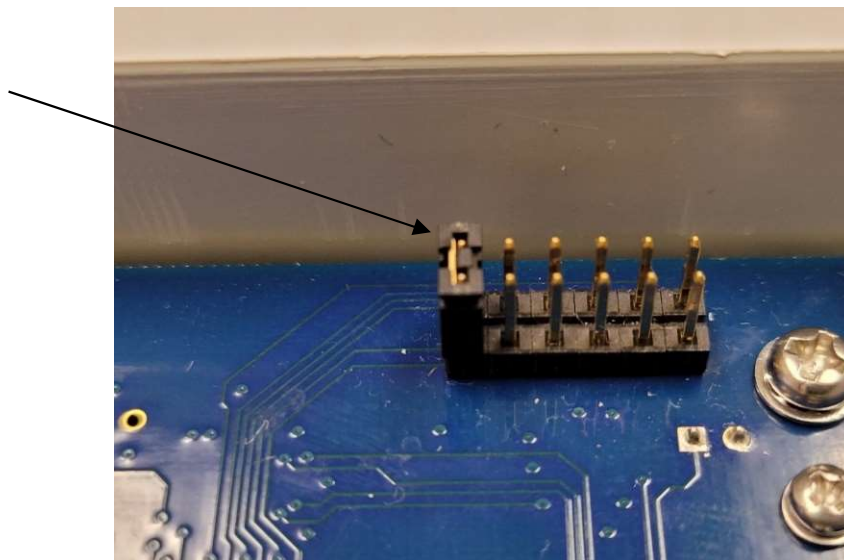
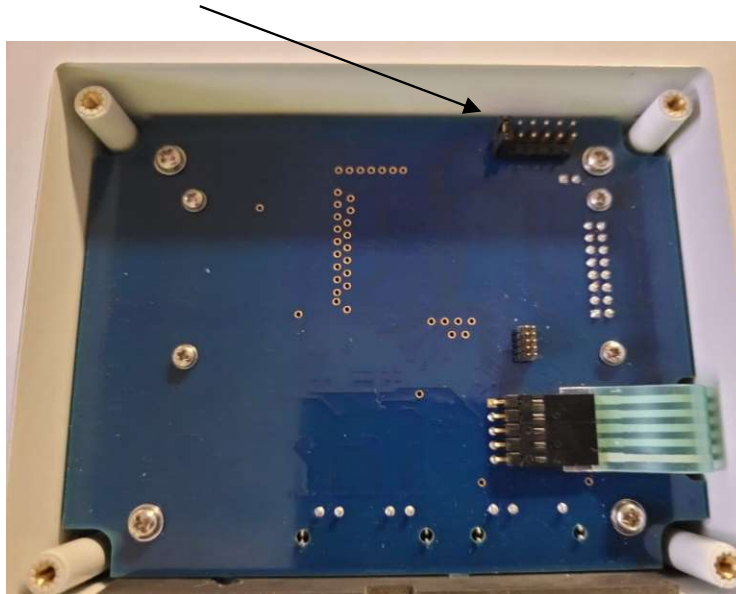

If the jumper is installed in the first slot the unit will display in degrees "F", with the jumper removed the unit will display in degrees "C". If the unit is ordered as a degree "C" unit the jumper will be removed at the factory and shipped loose in case the customer would like to switch it back to degree "F".

Proton 1.0 – User Screens

Home Screen: Current outlet temperature and Set point temperature



Home Screen: After initial “Full Sweep” the bottom line of the digital display indicates the measured sweep value of the valve, hot to cold. Please record this numerical value as you will need it for calibration Screen 2 below. If you “miss” the “full sweep” number simply unplug the unit and plug back in and the unit will do another sweep and give you the value. The digital display now indicates current measured temperature on the mixed outlet of the valve and shows set point temperature on the line below. **Note:** A large negative value displayed at the **Cur temp** line indicates the sensor is damaged or not properly wired to the main control board.

Temperature Adjustment: Temperature is easily adjusted by pressing the key code sequence **▲ ▼ ▲ ▼ ENTER** key. At this point, the Setpoint will flash, and the **▲** and **▼** keys can now be used to adjust temperature up or down. When desired value is reached, pressing the **ENTER** key will store the new set point temperature and a message stating that the set point has been saved will be displayed. If no new temperature is saved, the screen display will revert back to the Home Screen after approximately 10 seconds and the set point will remain unchanged. Symbols + and – indicate whether the outlet temperature is being adjusted higher (+) or lower (-) by the controller.

Standard Menu: Options on Board/Equipped:

Pressing either the **▲** or **▼** keys will allow a user to scroll through other data points, features and options of the valve and will show the following screens and features in order.

Note: **▼** key was used for this manual’s sequence and should be considered forward direction in the menu. Pressing the **▲** key will reverse the order and can be considered reverse direction.

Menu Screen 1: Main Power Supply



Pressing ▼ 1 time displays **POWER: 12.82**

This indicates the input supply voltage to the main control board, Volts DC, and should always be at least 12 VDC

Menu Screen 2: Firmware Revision



Pressing ▼ 2 times displays **FW Rev: X.X.X.X**

This screen shows the current version of Firmware loaded into the Proton processor. It may be used for reference and troubleshooting.

From ANY screen, the user must enter the CALIBRATION Menu in order to record the initial numerical Full Valve Sweep value (recorded in Step 10 above) for comparison to future Valve Sweep Values for any maintenance warnings moving forward on this device. To Enter Calibration: Press the ▲ ▼ buttons simultaneously. The following screen should appear:

Calibration Screen 1: RTD Probe Calibration



This Calibration Screen is used in the event that the outlet valve temperature display differs significantly from a downstream temperature measurement value. It is a way to OFFSET the outlet temperature in order to agree with another temperature measurement value. Press **ENTER** to adjust Cal value, it will flash. Use ▲ ▼ buttons to adjust Cal value (+/-) in order to agree with other values. Press **ENTER** to save the Cal value. If Calibration is not needed, Press the ▼ arrow to advance to the next screen.

Calibration Screen 2: Full Valve Sweep Counts



The above Calibration Screen is used to enter the initial Full Valve Sweep Value obtained and recorded in Step #10 from initial power up. Press **ENTER** to input FVS value, it will flash. Use ▲ button to adjust FVS counts value and advance until it agrees with the Initial Sweep Value recorded in Step #10 above. Press **ENTER** to save the FVS counts value. To Exit Calibration: Press the ▲▼ buttons simultaneously. This will return you to the HOME Screen:

Home Screen: Current outlet temperature and Set point temperature



The user is returned to the 'Home Screen' which displays current temperature as measured on valve outlet and the set point temperature on the line below.

Note: A large negative value displayed at the **Cur temp** line indicates the sensor is damaged or not properly wired to the main control board.

Note: Pressing the ▲ key will reverse the order previously shown and allow the user to scroll through the above menu items in reverse order.

Proton 1.0 Digitally Controlled Mixing Valve Error Codes

Error codes are displayed on the LCD screen. Errors must be manually cleared by pressing **ENTER** and the error condition has been corrected. There are 2 Error Codes on the Proton Digitally Controlled Mixing Valve. Error codes are listed below:

Error Code 1: Check Probe (Temperature Probe)



This Error indicates that the RTD Temperature Probe installed in the valve outlet is either disconnected from the Control Box or the wires are broken and it is in need of replacement. Please verify 3 wire connector on left side of control box is firmly engaged and verify that wires are continuous to the probe end. Replace if necessary. See Page 24 for details.

Error Code 2: Valve Service Required



This Error indicates that the Proton Valve has reached less than 90% of initial Sweep Value recorded in Step #10. This translates into lost motion on the shuttle and ultimately loss of ideal temperature control. The Mechanical Valve Components should be taken apart, cleaned of any and all debris or scale inside the valve body, inspected and serviced. Worn components must be replaced if necessary.

Error Code 3: T3 High or Low



This Error indicates that the outlet temperature (T3) is 10°F higher or lower than the outlet set point temperature. Error message will alternate with current outlet temperature. Error self clears once temperature is back within the $\pm 10^\circ\text{F}$ threshold. There are a variety of reasons this error can be shown, but most commonly the issue is an improper plumbing arrangement (See Piping Method W). Also check the wiring connections from the valve motor to the Proton Control Box.

PROTON 2.0, 2.5 & 3.0 – SETUP INSTRUCTIONS

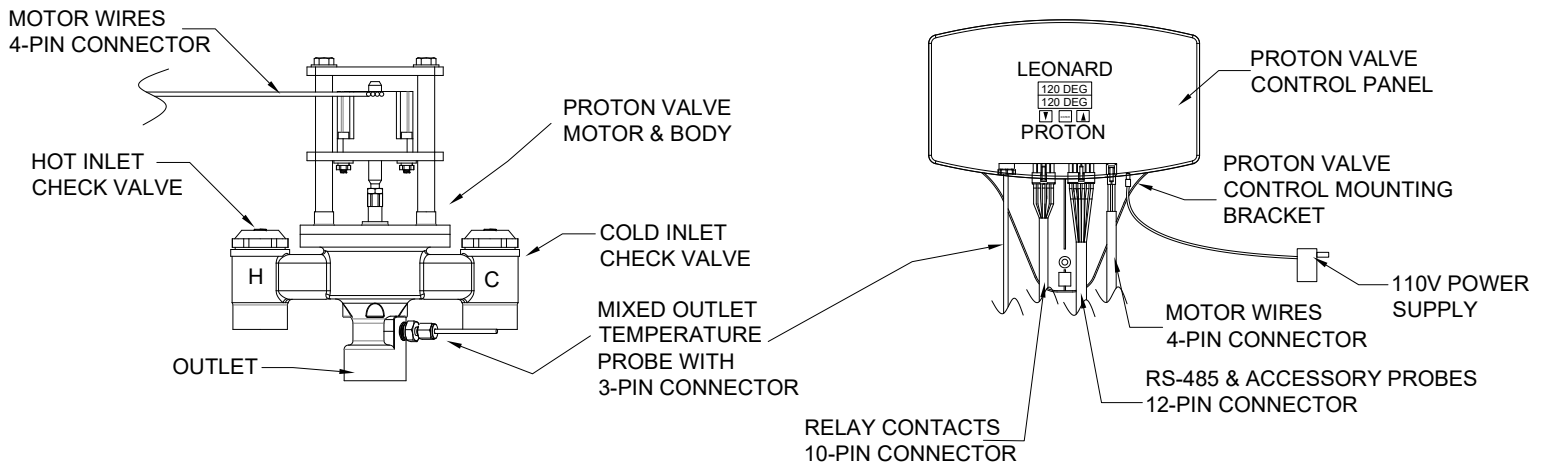

The Proton Control Box has a 2 Line, 16 character LED digital display screen, which serves as the User Interface by utilizing a simple 3-button keypad interface: ▼, ENTER and ▲, to change temperature see page 11.

On Initial Power up, the valve will go through a full sweep function, which moves the motor its full travel, end-to-end of hot and cold ports of the valve body. This process assigns a numerical value to the distance travelled by the motor, in steps, that will be used in future comparisons to indicate if there is a potential maintenance problem or internal mechanical issue with the components of the valve.



WARNING



The Leonard Proton Digital Mixing Valve is an electronically controlled device utilizing DC circuitry. The connection of the Electronic Control Box to the Mechanical Valve Components is very simple. There is a 3-wire RTD Temperature Probe as well as a 4-wire Motor Harness that must be connected and plugged into the box on the far left and right (respectively) connection points on the bottom of the Control Box. There also provisions for Normal Opened relay contacts (10-Pin) and RS-485 with an additional 3 channels for inlet hot, inlet cold and return temperatures (12-Pin). The 110V Power to the box is accomplished through the barrel connector on the bottom right side of the Control Box. Installer must follow detailed instructions below to ensure proper operation of valve.

Valve assembly is suitable for indoor use only

Valve outlet must face down and be piped to Method W, see page 25

•NOTE! READ ALL INSTRUCTIONS PRIOR TO INSTALLATION



PROTON 2.0, 2.5, 3.0 – INSTALLATION INSTRUCTIONS

1. The Proton Unit MUST be piped according to Leonard Required Piping Method W (see page 25).
2. Mount valve body, outlet facing down, and plumb inlet and outlet connections. DO NOT introduce water to the valve until completion of these instructions.
3. Mount Proton Control Box wall bracket to desired location, within 6' of Valve Body using suitable screws. Once mounting bracket is installed control box can be snapped into place.
4. Remove compression fitting from rear-right side of the valve outlet. Slide RTD Probe #1 through the compression fitting and insert into the rear-right side of the valve outlet. Tighten compression fitting by hand, and then tighten just 1/8 to 1/4 turn. DO NOT overtighten fitting. See page 24 for more detail.
5. Connect and plug in all connectors that have come with the Proton controller. See below for details.
6. Connect Barrel Connector to bottom right side of Control Box. This is 110Volt Power Supply.
7. Open all inlet and outlet check-stops and ball valves to pressurize Proton valve.
8. Plug power supply into 110V receptacle. GFCI receptacles are recommended. Installer to follow local electrical codes.
9. Powering Valve Control Box will cause the valve motor to initiate a FULL VALVE SWEEP (End to End), indicating that the motor has traveled 900-1500 Steps. Please Record this initial Full Valve Sweep Value _____ Following the FULL SWEEP, the valve is ready for use and the LED Screen will display the following:

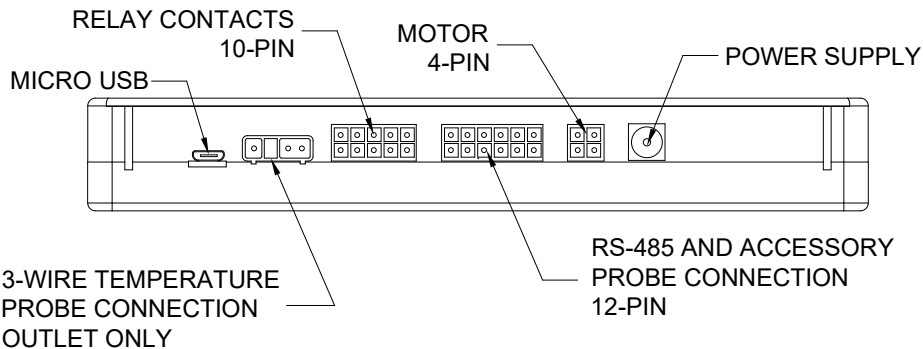

10-PIN CONNECTOR

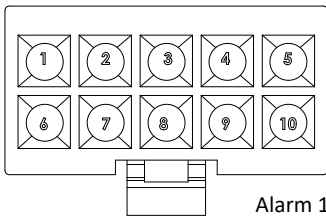

- Alarm 1 = Low Step Count – Service Valve
- Alarm 2 = Outlet Temperature Too High or Too Low
- Alarm 3 = RTD Probe Broken or Disconnected
- Alarm 4 = Valve Motor Broken or Disconnected
- Alarm 5 = Loss of Power to the Control Box

12-PIN CONNECTOR

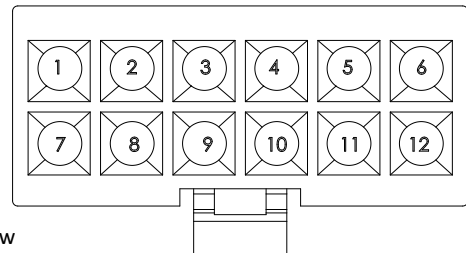

| ALARM | PIN | COLOR | FUNCTION |
|-------|-----|--------|---|
| 1 | 1 | RED | Sweep range alarm 0=clear, 1=set |
| | 5 | BLACK | |
| 2 | 2 | YELLOW | Temperature range alarm 0=clear, 1=set |
| | 6 | BLACK | |
| 3 | 3 | GREEN | Output temperature probe alarm 0=clear, 1=set |
| | 8 | BLACK | |
| 4 | 4 | BLUE | Motor continuity alarm 0=clear, 1=set |
| | 9 | BLACK | |
| 5 | 5 | WHITE | Power alarm 0=clear, 1=set |
| | 10 | BLACK | |

| ACCESSORY | PIN | NAME | COLOR | RTD | FUNCTION |
|-----------|-----|-------------------|--------|-----------------------------|-------------------------|
| 1 | 1 | RS-485+ | RED | FIELD INSTALLATION REQUIRED | RS485 for Bacnet |
| | 2 | RS-485- | WHITE | FIELD INSTALLATION REQUIRED | |
| | 3 | GROUND | BLACK | FIELD INSTALLATION REQUIRED | |
| 2 | 4 | GROUND (RTD2) | BLACK | WHITE | "Position 1" Hot Inlet |
| | 5 | EXCITATION (RTD2) | GREEN | BLACK | |
| | 6 | SIGNAL (RTD2) | YELLOW | BLACK | |
| 3 | 7 | GROUND (RTD3) | BLACK | WHITE | "Position 2" Cold Inlet |
| | 8 | EXCITATION (RTD3) | BLUE | BLACK | |
| | 9 | SIGNAL (RTD3) | ORANGE | BLACK | |
| 4 | 10 | GROUND (RTD4) | BLACK | WHITE | "Position 4" Return |
| | 11 | EXCITATION (RTD4) | PURPLE | BLACK | |
| | 12 | SIGNAL (RTD4) | GRAY | BLACK | |

Proton 2.0, 2.5 and 3.0 – User Screens

Home Screen: Current outlet temperature and Set point temperature



Home Screen: After initial “Full Sweep” the bottom line of the digital display indicates the measured sweep value of the valve, hot to cold. Please record this numerical value as you will need it for calibration Screen 2 below. If you “miss” the “full sweep” number simply unplug the unit and plug back in and the unit will do another sweep and give you the value. The digital display now indicates current measured temperature on the mixed outlet of the valve and shows set point temperature on the line below. **Note:** A large negative value displayed at the **Cur temp** line indicates the sensor is damaged or not properly wired to the main control board.

Temperature Adjustment: Temperature is easily adjusted by pressing the key code sequence **▲ ▼ ▲ ▼ ENTER** key. At this point, the Set point will flash, and the **▲** and **▼** keys can now be used to adjust temperature up or down. When desired value is reached, pressing the **ENTER** key will store the new set point temperature and a message stating that the set point has been saved will be displayed. If no new temperature is saved, the screen display will revert back to the Home Screen after approximately 10 seconds and the set point will remain unchanged. Symbols + and – indicate whether the outlet temperature is being adjusted higher (+) or lower (-) by the controller.

Standard Menu: Options on Board/Equipped:

Pressing either the **▲** or **▼** keys will allow a user to scroll through other data points, features and options of the valve and will show the following screens and features in order.

Note: **▼** key was used for this manual’s sequence and should be considered forward direction in the menu. Pressing the **▲** key will reverse the order and can be considered reverse direction.

Menu Screen 1: Main Power Supply

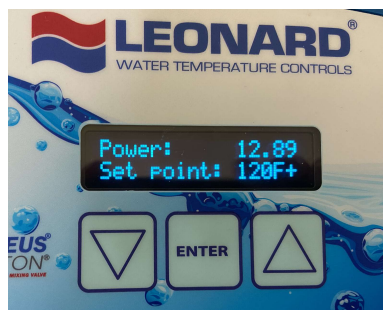

Pressing ▼ 1 time displays **POWER: 12.82**

This indicates the input supply voltage to the main control board, Volts DC, and should always be at least 12 VDC

Menu Screen 2: Firmware Revision



Pressing ▼ 2 times displays **FW Rev: X.X.X.X**

This screen shows the current version of Firmware loaded into the Proton processor. It may be used for reference and troubleshooting.

Menu Screen 3: Mode



Pressing ▼ 3 times displays **Mode: Proton**

This screen shows the Mode in which the controller is programmed. In this case, the controller should always read Proton. If another mode is displayed contact the Leonard Valve factory.

Optional Menu Screen 4: Cold Water Temperature



Pressing ▼ 1 time displays **Cold temp: XXX F or C**
This indicates the cold water inlet temperature to the Proton mixing valve.

Optional Menu Screen 5: Hot Water Temperature



Pressing ▼ 2 times displays **Hot temp: XXX F or C**
This indicates the hot water inlet temperature to the Proton mixing valve. If no sensor is installed this screen will not be displayed

Optional Menu Screen 6: Return Water Temperature



Pressing ▼ 2 times displays **Rtrn temp: XXX F or C**
This indicates the system return water temperature to the Proton mixing valve. If no sensor is installed this screen will not be displayed

From ANY screen, the user must enter the CALIBRATION Menu in order to record the initial numerical Full Valve Sweep value (recorded in Step 10 above) for comparison to future Valve Sweep Values for any maintenance warnings moving forward on this device. To Enter Calibration: Press the ▲ ▼ buttons simultaneously. The following screen should appear:

Calibration Screen 1: Outlet Probe Calibration

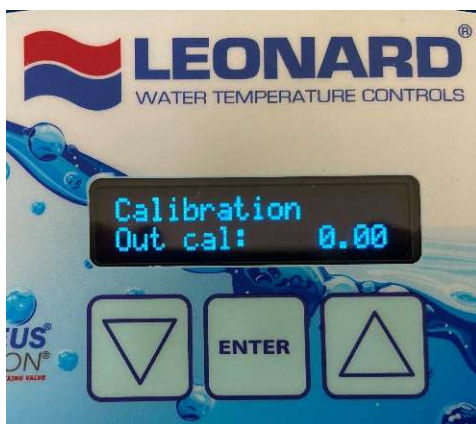

This Calibration Screen is used if the outlet valve temperature display differs significantly from a downstream temperature measurement value. It is a way to OFFSET the outlet temperature in order to agree with another temperature measurement value. Press **ENTER** to adjust Cal value, it will flash. Use ▲ ▼ buttons to adjust Cal value (+/-) in order to agree with other values. Press **ENTER** to save the Cal value. If Calibration is not needed, Press the ▼ arrow to advance to the next screen.

Calibration Screen 2: Hot Water Probe Calibration



This Calibration Screen is used if the hot water inlet temperature display differs significantly from a different temperature measurement value. It is a way to OFFSET the temperature in order to agree with another temperature measurement value. Press **ENTER** to adjust Cal value, it will flash. Use ▲ ▼ buttons to adjust Cal value (+/-) in order to agree with other values. Press **ENTER** to save the Cal value. If Calibration is not needed, Press the ▼ arrow to advance to the next screen.

Calibration Screen 3: Cold Water Probe Calibration



This Calibration Screen is used if the cold water temperature display differs significantly from a downstream temperature measurement value. It is a way to OFFSET the outlet temperature in order to agree with another temperature measurement value. Press **ENTER** to adjust Cal value, it will flash. Use ▲▼ buttons to adjust Cal value (+/-) in order to agree with other values. Press **ENTER** to save the Cal value. If Calibration is not needed, Press the ▼ arrow to advance to the next screen.

Calibration Screen 4: Return Water Probe Calibration



This Calibration Screen is used if the hot water inlet temperature display differs significantly from a different temperature measurement value. It is a way to OFFSET the temperature in order to agree with another temperature measurement value. Press **ENTER** to adjust Cal value, it will flash. Use ▲▼ buttons to adjust Cal value (+/-) in order to agree with other values. Press **ENTER** to save the Cal value. If Calibration is not needed, Press the ▼ arrow to advance to the next screen.

Calibration Screen 5: Full Valve Sweep Count



The above Calibration Screen is used to enter the initial Full Valve Sweep Value obtained and recorded in Step #10 from initial power up. Press **ENTER** to input FVS value, it will flash. Use ▲ button to adjust FVS counts value and advance until it agrees with the Initial Sweep Value recorded in during initial power up. Press **ENTER** to save the FVS counts value.

Calibration Screen 6: Scale



The above Calibration Screen is used to enter the temperature scale to be displayed by the controller. Press **ENTER** to change the value, it will flash. Use ▲ button to adjust to F (Fahrenheit) or C (Celsius). Press **ENTER** to save the Scale.

Calibration Screen 6: Bacnet



The above Calibration Screen is used to turn on or off the Bacnet capability of the Proton controller. Press **ENTER** to change the value, it will flash. Use ▲ button to adjust to Y (Yes – Data On) or N (No – Data Off). Press **ENTER** to save Bacnet state.

To Exit Calibration: Press the ▲ ▼ buttons simultaneously. This will return you to the HOME Screen:

Home Screen: Current outlet temperature and Set point temperature



The user is returned to the 'Home Screen' which displays current temperature as measured on valve outlet and the set point temperature on the line below.

Note: A large negative value displayed at the **Cur temp** line indicates the sensor is damaged or not properly wired to the main control board.

Note: Pressing the ▲ key will reverse the order previously shown and allow the user to scroll through the above menu items in reverse order.

Proton 2.0, 2.5 & 3.0 Digitally Controlled Mixing Valve Error Codes

Error codes are displayed on the LCD screen. Errors must be manually cleared by pressing **ENTER** and the error condition has been corrected. Error Codes on the Proton Digitally Controlled Mixing Valve are listed below.

Error Code 1: Check Probe (Temperature Probe)



This Error indicates that the Proton Valve has reached less than 90% of initial Sweep Value recorded during initial start up. This translates into lost motion on the shuttle and ultimately loss of ideal temperature control. The Mechanical Valve Components should be taken apart, cleaned of all debris or scale inside the valve body, inspected and serviced. Worn components must be replaced if necessary.

The error will also display when there is a loss of power to the motor or a loss of continuity. After servicing, the FVS number may need to be adjusted to match the new value via the calibration menu

Error Code 2: Valve Service Required



This Error indicates that the RTD Temperature Probe installed in the valve outlet is either disconnected from the Control Box or the wires are broken, and it needs replacement. Please verify 3 wire connector on left side of control box is firmly engaged and verify that wires are continuous to the probe end. Replace if necessary.

Error Code 3: T3 High or Low



This Error indicates that the outlet temperature (T3) is 10°F higher or lower than the outlet set point temperature. Error message will alternate with current outlet temperature. Error self clears once temperature is back within the $\pm 10^\circ\text{F}$ threshold. There are a variety of reasons this error can be shown, but most commonly the issue is an improper plumbing arrangement (See Piping Method W). Also check the wiring connections from the valve motor to the Proton Control Box.



Proton 2.0, 2.5 & 3.0 Digitally Controlled Mixing Valve Disinfection Mode

WARNING: The Proton Digitally Controlled Mixing Valve is equipped with the ability to program the valve to move to full hot position, which will allow ONLY high temperature hot supply water to enter the device and subsequently deliver that high temperature water downstream of the device. There is inherent risk in this procedure and it is a feature which allows the user to 'Disinfect' the plumbing system downstream of the device.

BEFORE THIS MODE IS ENGAGED, AN AUTHORIZED USER MUST BE AWARE OF THE POTENTIAL RISKS TO END USERS DOWNSTREAM OF THIS DEVICE, AND MUST ALSO MAKE PROVISIONS TO PUT SAFETY MEASURES IN PLACE DURING THE DISINFECTION STAGE TO ENSURE USER SAFETY. SEVERE BURNS, SEVERE INJURY AND/OR EVEN DEATH MAY OCCUR IF SUCH PROVISIONS ARE NOT IN PLACE ACTIVATING THIS FEATURE.

To enter Disinfection Model, Press the ▲ and ENTER buttons simultaneously and release.

Screen 1: Disinfection Mode

Press ENTER to advance to the next screen.



Screen 2: Minimum Disinfection Temperature

Set the minimum temperature the disinfection cycle will run at. If the outlet temperature falls below the minimum disinfection temperature the cycle will end. Default temperature is 158°F. Use the ▲ ▼ buttons to change value and press ENTER to advance to the next screen.



Proton 2.0, 2.5 & 3.0 Digitally Controlled Mixing Valve Disinfection Mode

Screen 3: Maximum Disinfection Temperature

Set the maximum temperature the disinfection cycle will run at. If the outlet temperature falls below the minimum disinfection temperature the cycle will end. Default temperature is 185°F. Use the ▲▼ buttons to change value and press ENTER to advance to the next screen.



Screen 4: Warmup

Set the time, in minutes, that should be allowed for the hot water inlet to the valve to warm up to disinfection-suitable temperatures. If temperature is not above Minimum or below the Maximum temperatures, the disinfection cycle will end. Use the ▲▼ buttons to change value and press ENTER to advance to the next screen.



Screen 5: Duration

Set the time, in hours and minutes, that the disinfection cycle run. Time is adjustable in 15 minute intervals. Use the ▲▼ buttons to change value and press ENTER to advance to the next screen.



Proton 2.0, 2.5 & 3.0 Digitally Controlled Mixing Valve Disinfection Mode

Confirmation Screens

Confirm each of the previous four parameters settings by pressing ENTER for each. Pressing either arrow will automatically end the disinfect cycle.



Once a disinfection cycle is initiated, the top line of the controller will display **Warmup** along with a timer that is counting down. The bottom line displays the current outlet temperature. If the outlet temperature does not reach the Minimum disinfection temperature within the allotted Warmup time, the disinfection cycle will automatically cancel. Pressing the ENTER button will end the disinfection cycle.



Proton 2.0, 2.5 & 3.0 Digitally Controlled Mixing Valve Disinfection Mode

When the outlet temperature reaches the Minimum disinfection temperature, the warmup screen will automatically change to a countdown of the **Stabilization** time. This lasts for 1 minute and is meant to ensure stable disinfection temperatures before the disinfection cycle timer starts.



After Stabilization, a new countdown for the Duration of disinfection with the current temperature outlet temperature displayed on the bottom line. If the temperature goes below the minimum or above the maximum disinfection temperatures, then the disinfection cycle will end automatically.

Disinfection cycle ends when the Duration timer is done counting down. The cycle can also be manually aborted by pressing the ENTER button at any time.



After a disinfection cycle is over, the controller will go into a Cooldown mode until the outlet temperature returns to set point temperature. Once the temperature is stable, the screen will revert to the standard home screen.



SENSOR TROUBLESHOOTING AND REPLACEMENT

When a sensor is disconnected or no longer in proper working condition, an error message is displayed on the controller **Err: Check Probe** See Error Code above.

TURN OFF POWER TO THE PROTON CONTROL BOX BEFORE TROUBLESHOOTING OR REPLACING ANY WIRES AND SENSORS.

Determine if the sensor is truly broken and not a simple disconnection. Please verify the 3-wire RTD Temperature Probe connector is firmly plugged into its location on the bottom left of the Proton Control Box.

If the sensor is properly connected to the controller and the condition persists, then the sensor needs to be replaced. Contact Local Leonard Valve Representation for part number

803203 – Outlet Sensor (All Proton Models)

809001 – Inlet/Return Sensor (Proton 2.5 or Greater)

1. Shut down hot, cold and outlet ball valves and depressurize the pipes. Remove the defective sensor from the piping and install new sensor in its place. For RTD probes new compression fittings are required. **Do not overtighten** compression nuts before re-pressurizing valve (**See Page 24**).
2. Open cold line and outlet ball valves to pressurize valve, once it is confirmed there are no leaks open the hot line as well. Introduce power to the Proton control box and confirm that the replacement sensor is providing proper feedback and data.

INSTALLING AND REPLACING TEMPERATURE PROBES

The RTD temperature probes used with Proton assemblies are simple to install. On the valve body the temperature probe is connected to the valve with a ¼" MNPT x ⅝" compression fitting. Teflon tape and a small amount of thread sealant should be used on the NPT side of the fittings. The ferrule, installed with the cone facing down, then sits on the top of the compression inlet. The compression nut is then put over the ferrule and tightened slightly, just enough to hold the ferrule in place. The RTD temperature probe is then inserted through the entire fitting until the end of the probe reaches approximately the center of the desired measured water stream. Finally, the compression nut is tightened by hand to "hand-tight" plus ⅛ to ¼ turn with an adjustable or open end wrench. **Use caution not to overtighten the fitting and only tighten until dripping stops.**

NOTE: if overtightened, leaks are probable and the entire RTD and compression fitting must be replaced!

Replacement part #803203



INSTALLATION OF COMPRESSION FITTING AND OUTLET RTD PROBE ON 2" PROTON VALVE BODY

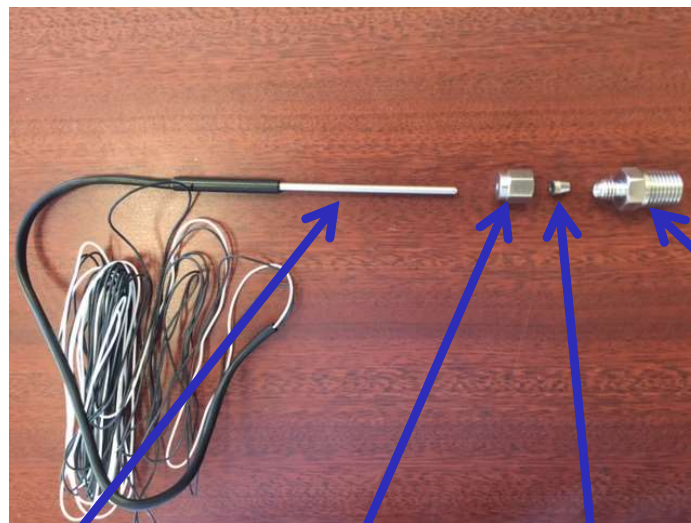

RTD Probe with
10' Lead Wire

Compression Nut

Ferrule

¼" NPT x ⅝" Compression Fitting

REQUIRED PIPING METHOD W

HIGH TEMPERATURE FIXTURES (IF APPLICABLE)

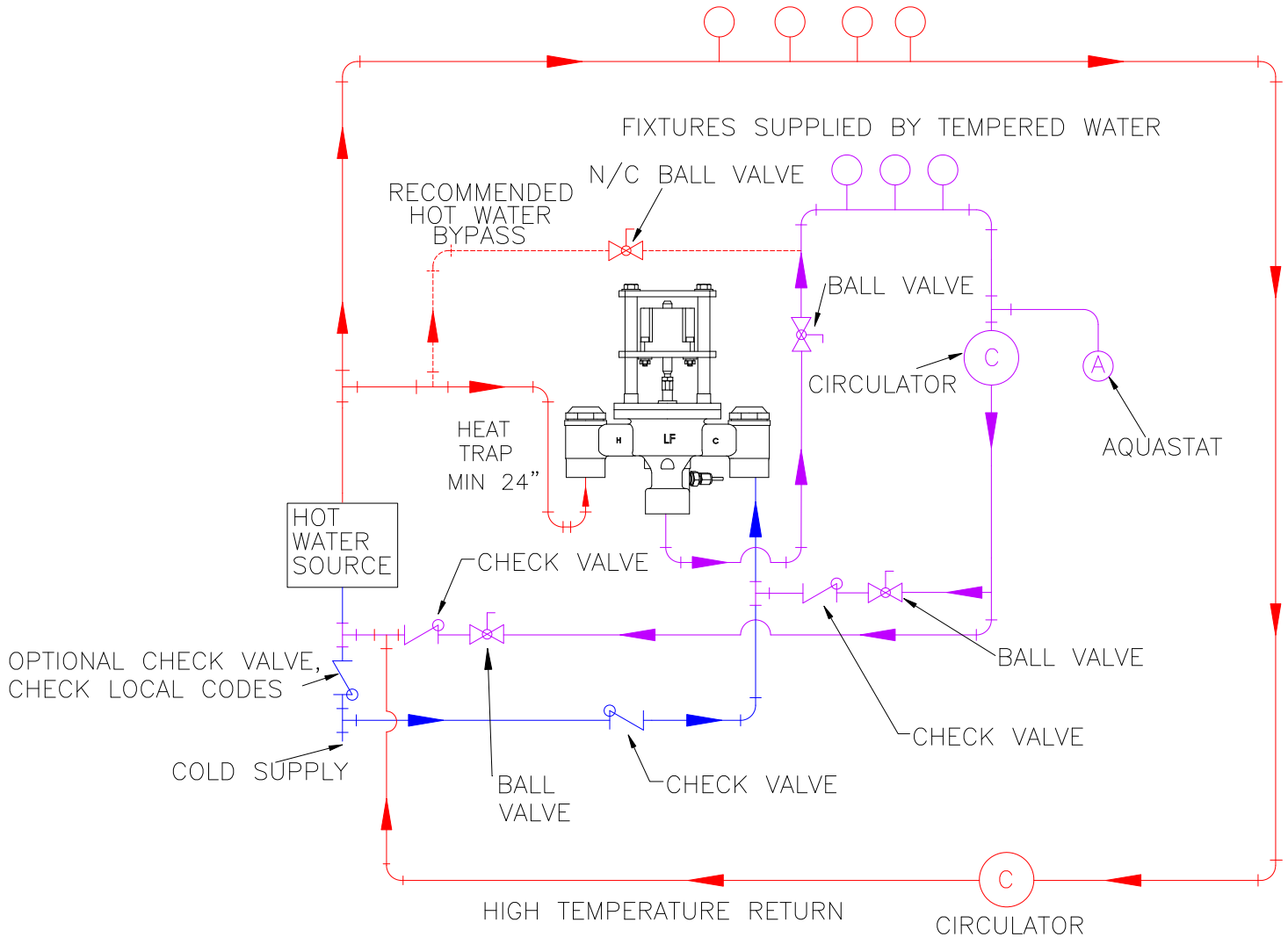

NOTE:

- "LCV" MODELS REQUIRE INLET CHECK VALVES TO PREVENT CROSS FLOW, INLET BALL VALVES ARE ALSO RECOMMENDED FOR ISOLATION / MAINTENANCE
- FOR MULTIPLE TEMPERED LOOPS, A BALANCING VALVE AND CHECK VALVE MUST BE INSTALLED ON EACH LOOP AFTER TEMPERED FIXTURES

| | |
|--|--|
| <p>Leonard Proton Digital Mixing Valves are simple in design and may be easily cleaned, adjusted and repaired. If the installation is accessible, servicing may be completed without disconnecting the valves.</p> | <p>NOTE: Leonard Proton Digital Mixing Valves must be regularly maintained to provide best performance. Frequency of cleaning depends on quality of local water conditions and usage. See Maintenance Guide and Record MGR-1000</p> |
|--|--|

BMS CONNECTION PROCEDURE

USE THE INSTRUCTIONS BELOW TO CONNECT PROTON 2.5 AND 3.0 TO A BUILDING MANAGEMENT SYSTEM (BMS)

1. Connect the Proton control box to the BMS using 12-Pin connector. Wiring is shown on Page 10.
2. Power up the Proton control box. Power must be on to be able to configure BMS settings.
3. Connect a laptop to the Proton control box via the Micro-USB port located on the bottom of the box.
4. Download **LEONARD NPU**. After unzipping the file, navigate to the NPU application. See www.leonardvalve.com for the files.
5. Once the application is running, the application should automatically recognize the BMS card installed in the Proton control box. Now the protocol can be selected, BACnet MS/TP or Modbus RTU Slave. Changes can be made to the network parameters once the protocol is selected.
6. Once parameters are set, click on 'Submit' to save them.

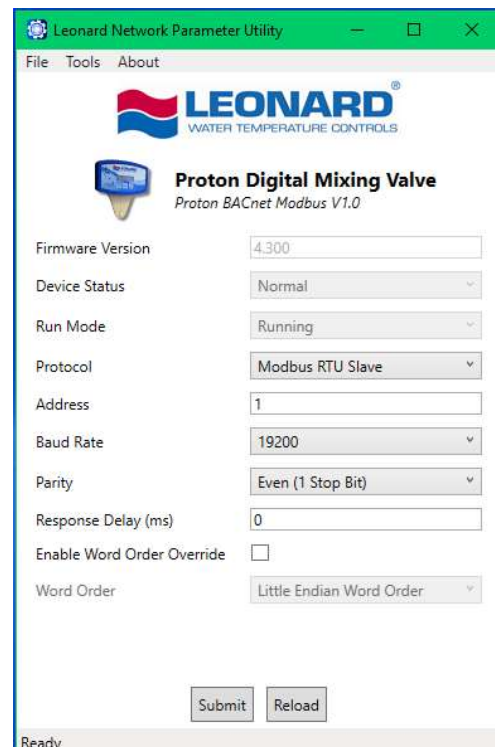
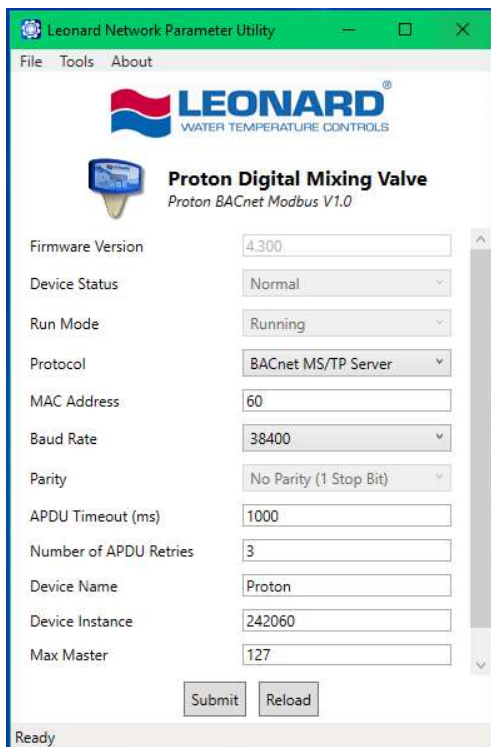
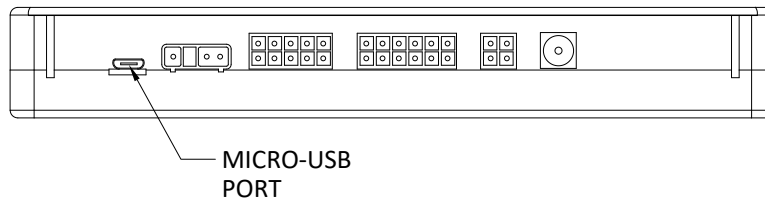

BACnet OBJECT LIST

| Object Name | Object Type | Instance | Units | Default COV Increment | Active Text | Inactive Text | Polarity | Number of States | Notes |
|-----------------|-------------------|----------|----------|-----------------------|-------------|---------------|----------|------------------|--------------------------------------|
| TempOut | Analog Input | 0 | no-units | | 1 N/A | N/A | N/A | N/A | °F or °C |
| TempHotIn | Analog Input | 1 | no-units | | 1 N/A | N/A | N/A | N/A | °F or °C |
| TempColdIn | Analog Input | 2 | no-units | | 1 N/A | N/A | N/A | N/A | °F or °C |
| TempReturnIn | Analog Input | 3 | no-units | | 1 N/A | N/A | N/A | N/A | °F or °C |
| Alarm1 | Binary Input | 0 | N/A | N/A | Alarm | Normal | Normal | N/A | 0 = Off 1 = On |
| Alarm2 | Binary Input | 1 | N/A | N/A | Alarm | Normal | Normal | N/A | 0 = Off 1 = On |
| Alarm3 | Binary Input | 2 | N/A | N/A | Alarm | Normal | Normal | N/A | 0 = Off 1 = On |
| Alarm4 | Binary Input | 3 | N/A | N/A | Alarm | Normal | Normal | N/A | 0 = Off 1 = On |
| Alarm5 | Binary Input | 4 | N/A | N/A | Alarm | Normal | Normal | N/A | 0 = Off 1 = On |
| FlowSwitchState | Multi-state Input | 0 | N/A | N/A | N/A | N/A | N/A | 3 | 1 = Off 2 = On 3 = Unsupported |

MODBUS OBJECT LIST

Register/discrete numbering is 1-based

32-Bit registers are comprised of two 16-bit registers, least significant register first

| Description | Type | Register/Discrete Number | Data Type | Notes |
|--------------|----------------|--------------------------|---------------------------|---|
| Alarm1 | Discrete Input | | 1 N/A | |
| Alarm2 | Discrete Input | | 2 N/A | |
| Alarm3 | Discrete Input | | 3 N/A | |
| Alarm4 | Discrete Input | | 4 N/A | |
| Alarm5 | Discrete Input | | 5 N/A | |
| Flow State | Input Register | | 1 16-Bit Unsigned Integer | 0 = Off 1 = On 2 = Unsupported All other values = Reserved |
| TempOut | Input Register | | 2 32-Bit Floating Point | °F or °C |
| TempHotIn | Input Register | | 4 32-Bit Floating Point | °F or °C |
| TempColdIn | Input Register | | 6 32-Bit Floating Point | °F or °C |
| TempReturnIn | Input Register | | 8 32-Bit Floating Point | °F or °C |

Alarm 1 = Low Step Count – Service Valve

Alarm 2 = Outlet Temperature Too High or Too Low

Alarm 3 = RTD Probe Broken or Disconnected

Alarm 4 = Valve Motor Broken or Disconnected

Alarm 5 = Loss of Power to the Control Box

WI-FI CONNECTION PROCEDURE

USE THE INSTRUCTIONS BELOW TO CONNECT PROTON 3.0 TO A WI-FI NETWORK

1. Power up the control box and get into the calibration mode by pressing the ↑ and ↓ arrows at the same time and then letting go.
2. Scroll to the “Wi-Fi” menu screen using the ↑ and ↓ arrows. Press **ENTER** and change the setting to “Y” using the ↑ and ↓ arrows. Press **ENTER** to in the new setting.



3. Press the ↑ and ↓ arrows at the same time and then let go to get back to the home screen. Cycle power to the controller.
4. Connect a MicroUSB cable to the controller located on the bottom-left of the controller. The other end of the cable should be connected to a computer.



5. Open the Proton3ToolV19 and select the connection port that the controller is connected to. This tool can be found at the Leonard Valve website, www.leonardvalve.com.
6. Once connected, press the “Query” button to bring up the current settings. If a new box is being set up, the fields will be completely blank. In cases where the controller has already been commissioned, the “Query” button will show all current settings.
7. Fill in the parameters for each setting. Note that the controller will need its own dedicated e-mail address that will need to be set up by facility IT personnel. An example of a filled-out parameter list is below.

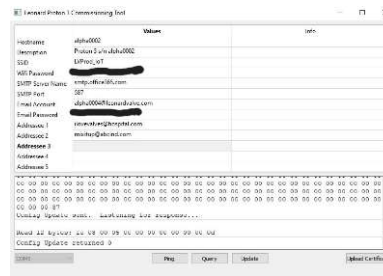
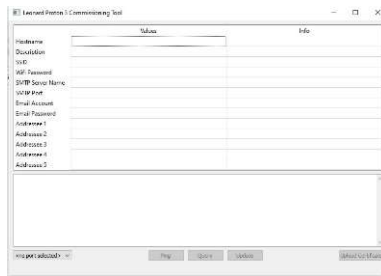

8. If necessary, IT personnel will need to also upload a certificate. This can be provided by the IT network managers.
9. Click on “Update” to save the settings and cycle power to the controller.
10. Open a browser and type in **http://** followed by the hostname entered in the Proton 3 commissioning tool along with /dashboard. For example, for the previous screenshot, the site should be entered as **http://alpha0002/dashboard**. Below is what the landing page should look like. Bookmark this page for later reference and disconnect MicroUSB cable.



| PNV100 | PNV125 | KIT TYPE | INCLUDES |
|---------------|---------------|-----------------|-----------------|
| KIT 1/PNV1 | KIT 1/PNV2 | O-RING KIT | 1 - 4 |
| KIT R/PNV1 | KIT R/PNV2 | COMPLETE REPAIR | 1 - 6 |
| KIT 2/50 | KIT 2/50 | CHECK KIT | 7 - 10 |

#14 cover assembly includes

- Cover, plates
- Motor
- Stem
- O-rings
- Shuttle

All fully assembled

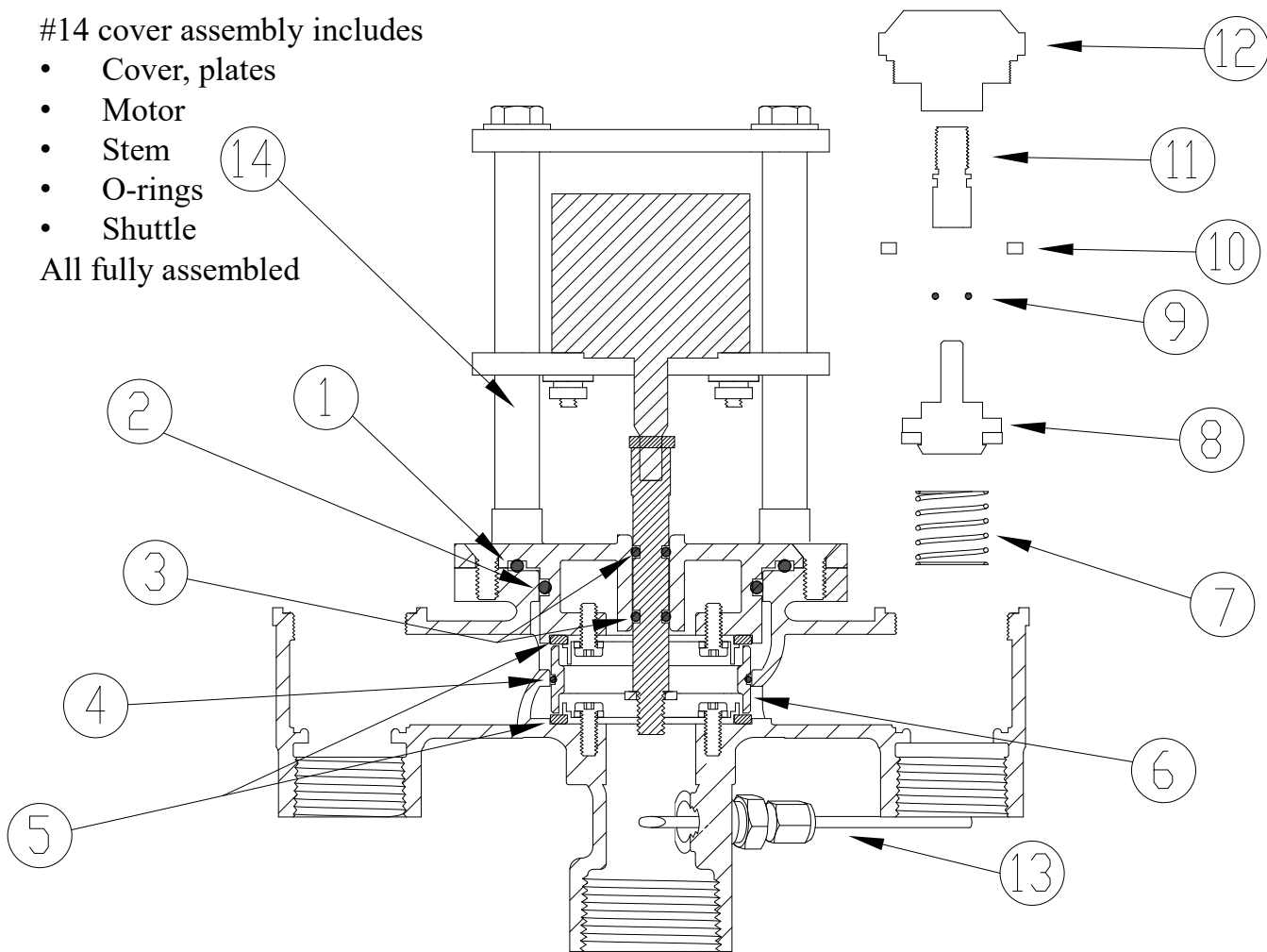

| ITEM # | DESCRIPTION | QTY. | PNV100 | PNV125 |
|---------------|--------------------------|-------------|------------------------|------------------------|
| 1 | O-RING, COVER | 1 | KIT 1/PNV1, KIT R/PNV1 | KIT 1/PNV2, KIT R/PNV2 |
| 2 | O-RING, COVER | 1 | KIT 1/PNV1, KIT R/PNV1 | KIT 1/PNV2, KIT R/PNV2 |
| 3 | O-RING, STEM | 2 | KIT 1/PNV1, KIT R/PNV1 | KIT 1/PNV2, KIT R/PNV2 |
| 4 | O-RING, SHUTTLE | 1 | KIT 1/PNV1, KIT R/PNV1 | KIT 1/PNV2, KIT R/PNV2 |
| 5 | SEAT, HOT / COLD | 2 | KIT R/PNV1 | KIT R/PNV2 |
| 6 | SHUTTLE | 1 | KIT R/PNV1 | KIT R/PNV2 |
| 7 | SPRING | 2 | 011, KIT 2/50 | 011, KIT 2/50 |
| 8 | LOWER STEM W/PACKING | 2 | 03, KIT 2/50 | 03, KIT 2/50 |
| 9 | O-RING, UPPER STEM | 2 | MU-5A, KIT 2/50 | MU-5A, KIT 2/50 |
| 10 | PACKING, BONNET | 2 | 05, KIT 2/50 | 05, KIT 2/50 |
| 11 | UPPER STEM | 2 | MU-4A RF | MU-4A RF |
| 12 | BONNET | 2 | 02 RF | 02 RF |
| 13 | THERMOCOUPLE AND FITTING | 1 | 803203 | 803203 |
| 14 | COVER ASSEMBLY | 1 | * SEE PAGE 33 | * SEE PAGE 33 |

| PNV150 / PNV200 | KIT TYPE | INCLUDES |
|-----------------|-----------------|----------|
| KIT R/NV | COMPLETE REPAIR | 1 - 8 |
| KIT 1/NV | O-RING | 1 - 5 |

#10 cover assembly includes

- Cover, plates
- Motor
- Stem
- O-rings
- Shuttle

All fully assembled

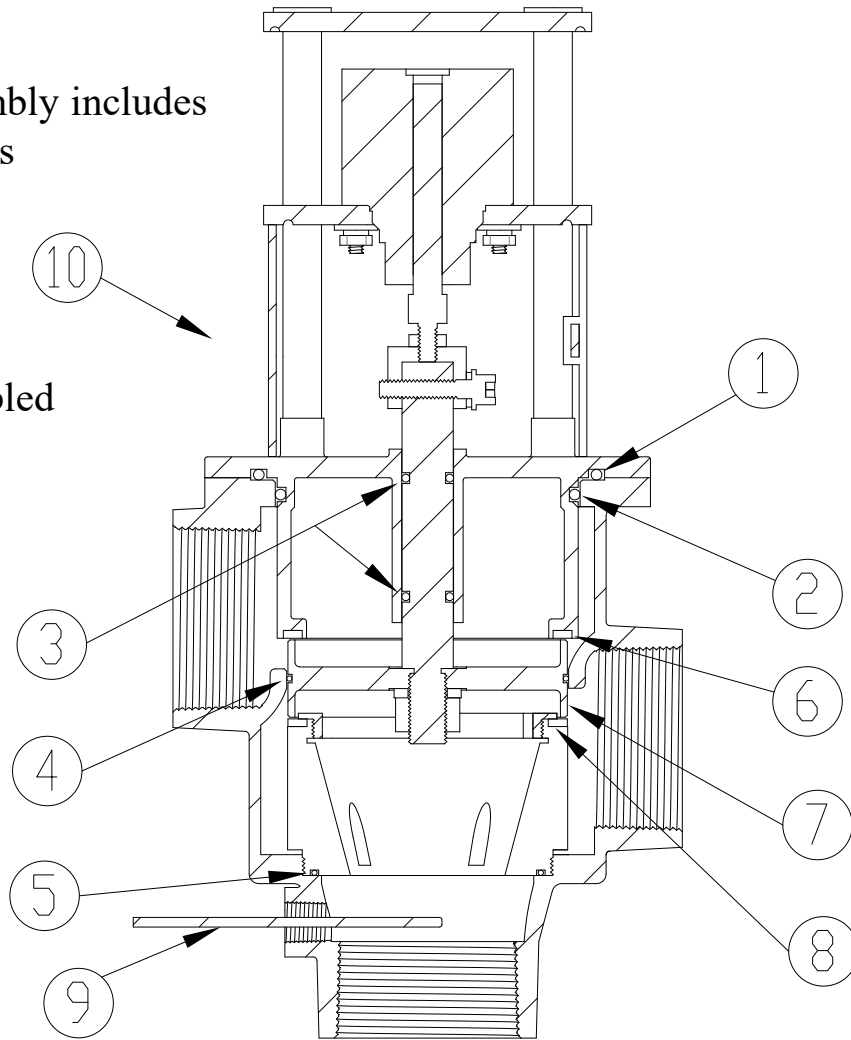

| ITEM # | DESCRIPTION | QTY. | PNV150 / PNV200 |
|--------|--------------------------|------|--------------------|
| 1 | O-RING, COVER | 1 | KIT 1/NV, KIT R/NV |
| 2 | O-RING, COVER | 1 | KIT 1/NV, KIT R/NV |
| 3 | O-RING, STEM | 2 | KIT 1/NV, KIT R/NV |
| 4 | O-RING, SHUTTLE | 1 | KIT 1/NV, KIT R/NV |
| 5 | O-RING, SLEEVE | 1 | KIT 1/NV, KIT R/NV |
| 6 | SEAT, HOT SIDE | 1 | KIT R/NV |
| 7 | SHUTTLE | 1 | KIT R/NV |
| 8 | SEAT, COLD SIDE | 1 | KIT R/NV |
| 9 | THERMOCOUPLE AND FITTING | 1 | 803203 |
| 10 | COVER ASSEMBLY | 1 | * SEE PAGE 33 |

PNV-150-LF, 1-1/4" CHECKS

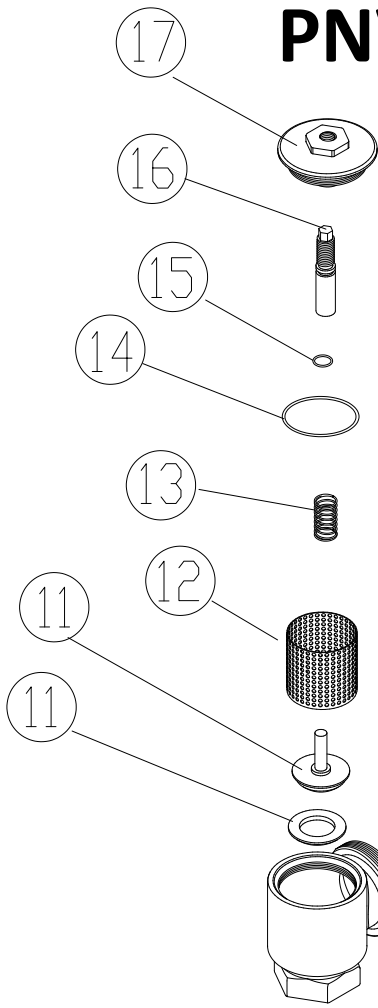

| KIT | DESCRIPTION | INCLUDES |
|-----------|-------------|----------|
| KIT 4/984 | REBUILD KIT | 11-15 |

| ITEM # | DESCRIPTION | QTY. | PART # / KIT # |
|--------|---|------|----------------|
| 11 | LOWER STEM & PACKING | 2 | KIT 4/984 |
| 12 | SCREEN | 2 | KIT 4/984 |
| 13 | SPRING,CHECK | 2 | KIT 4/984 |
| 14 | O-RING, COVER | 2 | KIT 4/984 |
| 15 | O'RING, UPPER STEM | 2 | KIT 4/984 |
| 16 | STEM, UPPER CHECK | 2 | 1761 |
| 17 | CHECK BONNET | 2 | 1786 |
| 18A | SWIVEL, SERIAL #'S PNV1500001 TO PNV1500114 | 2 | 04/125 RF |
| 18B | SWIVEL, SERIAL #'S PNV1500115 AND ABOVE | 2 | 8097 |
| 19 | SWIVEL NUT | 2 | 09/125 RF |

PNV-200-LF, 2" CHECKS

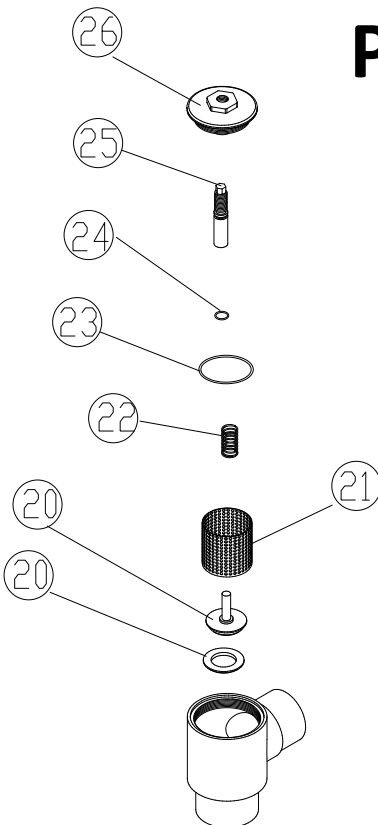

| KIT | DESCRIPTION | INCLUDES |
|-------------|-------------|----------|
| KIT 2/200/C | REBUILD KIT | 20-24 |

| ITEM # | DESCRIPTION | QTY. | PART # / KIT # |
|--------|----------------------|------|----------------|
| 20 | LOWER STEM & PACKING | 2 | KIT 2/200/C |
| 21 | SCREEN | 2 | KIT 2/200/C |
| 22 | SPRING,CHECK | 2 | KIT 2/200/C |
| 23 | O-RING, COVER | 2 | KIT 2/200/C |
| 24 | O'RING, UPPER STEM | 2 | KIT 2/200/C |
| 25 | STEM, UPPER CHECK | 2 | 4727 |
| 26 | CHECK BONNET | 2 | 4723 |

REMEMBER! THIS IS A CONTROL DEVICE WHICH MUST BE CLEANED AND MAINTAINED ON A REGULAR BASIS (SEE MAINTENANCE GUIDE AND RECORD)

| PNV300 | KIT TYPE | INCLUDES |
|-----------|-----------------|----------|
| KIT R/NV3 | COMPLETE REPAIR | 1 - 8 |
| KIT 1/NV3 | O-RING | 1 - 5 |

#10 cover assembly includes

- Cover, plates
- Motor
- Stem
- O-rings
- Shuttle

All fully assembled

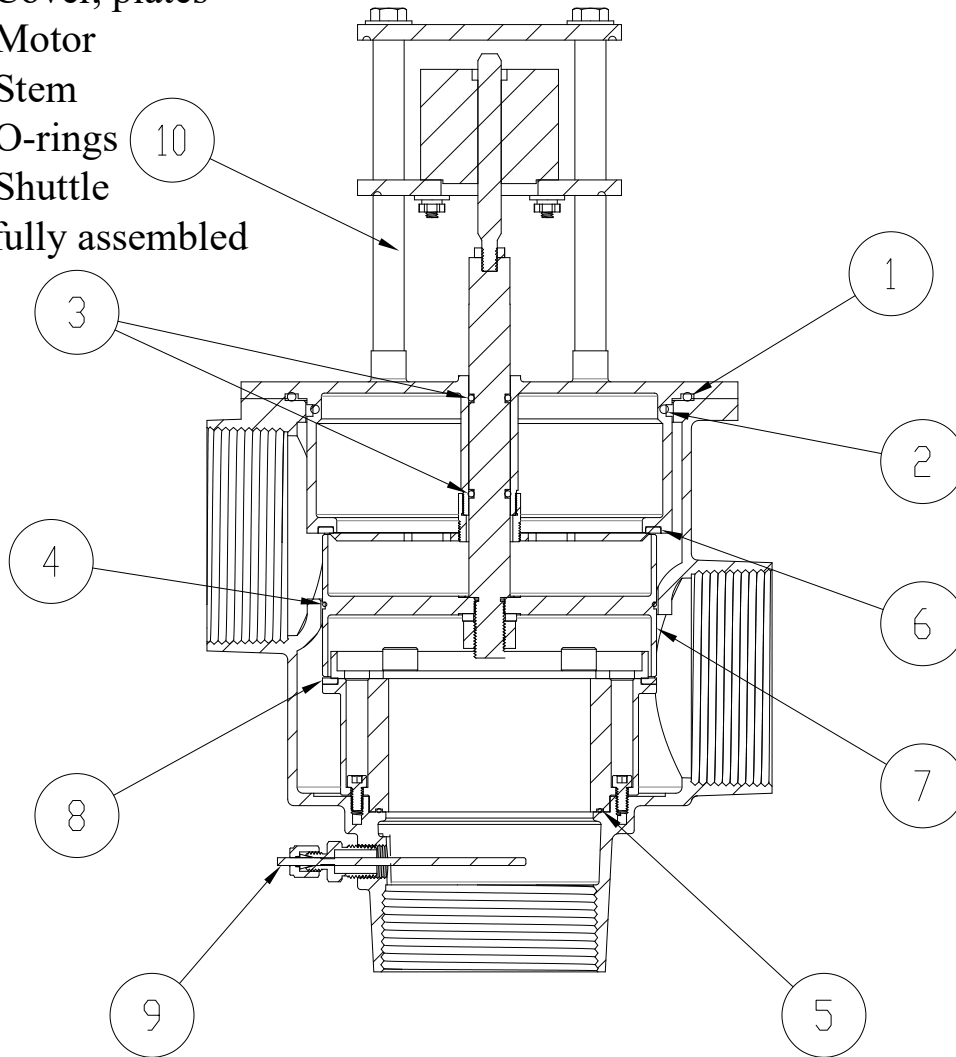

| ITEM # | DESCRIPTION | QTY. | PNV300 |
|--------|--------------------------|------|----------------------|
| 1 | O-RING, COVER | 1 | KIT 1/NV3, KIT R/NV3 |
| 2 | O-RING, COVER | 1 | KIT 1/NV3, KIT R/NV3 |
| 3 | O-RING, STEM | 2 | KIT 1/NV3, KIT R/NV3 |
| 4 | O-RING, SHUTTLE | 1 | KIT 1/NV3, KIT R/NV3 |
| 5 | O-RING, SLEEVE | 1 | KIT 1/NV3, KIT R/NV3 |
| 6 | SEAT, HOT SIDE | 1 | KIT R/NV3 |
| 7 | SHUTTLE | 1 | KIT R/NV3 |
| 8 | SEAT, COLD SIDE | 1 | KIT R/NV3 |
| 9 | THERMOCOUPLE AND FITTING | 1 | 803203 |
| 10 | COVER ASSEMBLY | 1 | * SEE PAGE 33 |

PLEASE NOTE:

Replacement cover assemblies will vary depending on which controller is with the mixing valve, see below to distinguish between the two,

1.0



2.0, 2.5, 3.0



| VALVE | DESCRIPTION | 1.0 | 2.0, 2.5, 3.0 |
|---------|----------------|--------|---------------|
| PNV-100 | COVER ASSEMBLY | 892400 | 892499 |
| PNV-125 | COVER ASSEMBLY | 890400 | 890499 |
| PNV-150 | COVER ASSEMBLY | 898105 | 898188 |
| PNV-200 | COVER ASSEMBLY | 898105 | 898188 |
| PNV-300 | COVER ASSEMBLY | 898106 | 898199 |

| MODEL | IN | OUT | MINIMUM FLOW GPM | PRESSURE DROP | | | | | | | | | | |
|------------|--------------------|--------------------|---------------------|---------------|-----|-----|-----|-----|-----|-----|------|------|------|-------|
| | | | | 5 | 10 | 15 | 20 | 25 | 30 | 35 | 40 | 45 | 50 | PSI |
| | | | | L/MIN | 0.3 | 0.7 | 1.0 | 1.4 | 1.7 | 2.1 | 2.4 | 2.8 | 3.1 | 3.4 |
| PNV-100-LF | 3/4" (19.1mm) | 1" (25.4mm) | 0.0* | 17 | 25 | 28 | 32 | 36 | 39 | 43 | 45 | 48 | 51 | GPM |
| | | | 0.0* | 64 | 95 | 106 | 121 | 136 | 148 | 163 | 170 | 182 | 193 | L/MIN |
| PNV-125-LF | 1" (25.4mm) | 1 1/4" (31.7mm) | 0.0* | 40 | 56 | 66 | 77 | 86 | 95 | 104 | 109 | 114 | 120 | GPM |
| | | | 0.0* | 151 | 212 | 250 | 291 | 326 | 360 | 394 | 413 | 432 | 454 | L/MIN |
| PNV-150-LF | 1-1/4" (31.7mm) | 1-1/2" (38.1mm) | 0.0* | 50 | 72 | 86 | 100 | 115 | 122 | 136 | 140 | 158 | 165 | GPM |
| | | | 0.0* | 189 | 273 | 326 | 379 | 435 | 462 | 515 | 530 | 598 | 625 | L/MIN |
| PNV-200-LF | 2" (50.8mm) | 2" (50.8mm) | 0.0* | 80 | 115 | 130 | 147 | 165 | 173 | 189 | 198 | 215 | 226 | GPM |
| | | | 0.0* | 303 | 435 | 492 | 556 | 625 | 655 | 715 | 750 | 814 | 856 | L/MIN |
| PNV-300-LF | 3" (76.2mm) | 3" (76.2mm) | 0.0* | 97 | 135 | 163 | 191 | 213 | 235 | 262 | 288 | 296 | 303 | GPM |
| | | | 0.0* | 366 | 510 | 616 | 722 | 805 | 888 | 990 | 1089 | 1119 | 1145 | L/MIN |

* NOTE: THE VALVE WILL MAINTAIN TEMPERATURE WITH 0.0 GPM FLOW FROM THE DOMESTIC HOT WATER LOOP WHEN PROPERLY INSTALLED NEAR THE HOT WATER SOURCE WITH A CONTINUOUSLY OPERATING RECIRCULATION PUMP AT 2.5 GPM FOR PNV-100, 3 GPM FOR PNV-125, 5 GPM FOR PNV-150 AND PNV-200, 10 GPM for PNV-300.

CAUTION! ALL THERMOSTATIC WATER MIXING VALVES AND SYSTEMS HAVE LIMITATIONS! THEY WILL NOT PROVIDE THE DESIRED PERFORMANCE OUTSIDE OF THEIR FLOW CAPACITY RANGE! CONSULT THE CAPACITY CHART BELOW AND OBSERVE MINIMUM FLOWS SHOWN.

LIMITED WARRANTY

Leonard Valve Company (hereinafter, "Leonard") warrants the original purchaser that products manufactured by Leonard will be free from defects in material or workmanship under normal conditions of use, when properly installed and maintained in accordance with Leonard's instructions, for a period of one year from the date of shipment. During this period, Leonard will at its option repair or replace any product, or part thereof, which shall be returned, freight prepaid, to the Leonard factory and determined by Leonard to be defective in materials or workmanship. Leonard provides no warranty, express or implied, which extends beyond the description contained herein. LEONARD SPECIFICALLY DISCLAIMS ANY AND ALL IMPLIED WARRANTIES OF MERCHANTABILITY OR OF FITNESS FOR A PARTICULAR PURPOSE. Nonetheless, some jurisdictions may not allow the disclaimer of certain implied warranties, in which case Leonard hereby limits such implied warranties to the duration of the limited warranty period contained herein. Some jurisdictions may not allow limitations on how long an implied warranty lasts, so the foregoing durational limitation may not apply to you. In no event will Leonard be liable for labor or incidental or consequential damages. Any alteration or improper installation or use of this product will void this limited warranty. If any provision of this limited warranty is prohibited by law in the applicable jurisdiction, such provision shall be null and void, but the remainder of this limited warranty shall continue in full force and effect.